

















CONTENTS

	ADBOX	4-7		QUIKFRAME	28-31
	FABRICWALL	8-9		INFRAME <i>NEW!</i>	32-33
	FABRICOUNTER <i>NEW!</i>	10-11		TRIMLITE <i>NEW!</i>	34-35
	STRETCHWALL <i>NEW!</i>	12-13		LIGHTBOX	36-37
	ROLL-IT-UP 4	14-15		PLENTYWALL <i>NEW!</i>	38-39
	ROLL-IT-UP 1	16-17		INFOSTAND	40-41
	ROLL-IT-UP 3	18-19		POSTERSTAND 1 & 2	42-43
	IMAGESTAND 1	20-21		EXSTREAM	44-45
	IMAGESTAND 2	22-23		ROUND-UP <i>NEW!</i>	46-49
	ADAPT	24-25		PROMOTOR	50-51
	POP-IT-UP	26-27		FLAGSTAND <i>NEW!</i>	52-53

LEGEND

TRANSPORT	 car	 SUV
	 cube van	 vehicle required depends on size
ASSEMBLY	 tool-free	 requires tools
	ASSEMBLY TIME	 30 sec estimated time



TRANSPORTCASE 1 & 2 54-55

SOFTCASE *NEW!* 56

INSPIRATION *NEW!* 57-58

ADBOX®

Many Configurations. One Powerful Display.

Make a mural. Suspend it. Create a countertop product display. Adbox can handle it. With brilliant graphics printed on high-grade e-flute, Adbox is incredibly lightweight and comes flat packed. It's eco-friendly and makes a big impact on your audience but not the environment.

From the simplest ledge display to a full mural backdrop, Adbox has your needs covered. Not sure who's watching your back? With double-sided graphics, Adbox makes good impressions all around.

Adbox is still probably the most innovative P-O-P display solution available.

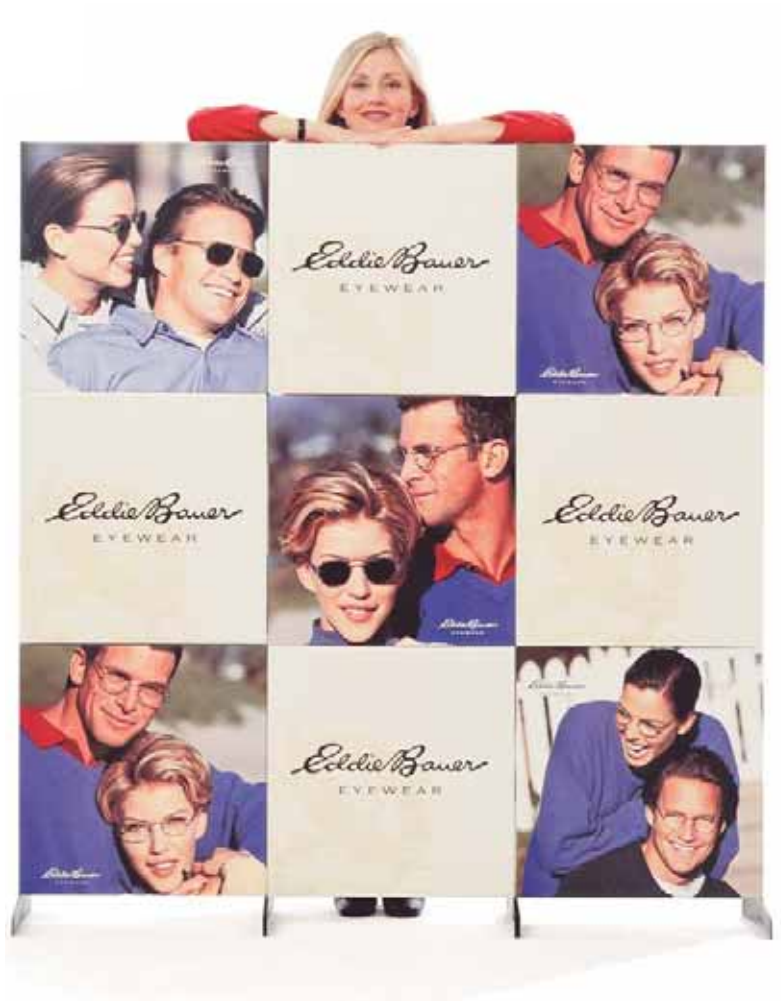

SPECIFICATIONS

A combination of high quality printed boxes along with a flexible connector system offers you a multitude of sizes and configurations – from countertop to wall-size promotions. They're extremely lightweight, and set-up fast and easy, no tools required.

Adbox units will be litho-printed for large-run projects of over 200 displays. Digital printing will be used for small-run projects.



Adbox ships flat. 9 pcs. of flat boxes with all the feet and connectors fit in a 3.5" high carton box, and folded up at time of assembly.

The configuration on the opposite side is shown below in parts to describe the principle.

- 1** Fold the two flaps toward each other to interlock.
- 2** Insert the "feet" into the bottom of one of the boxes.
- 3** Insert double tab "feet" into bottom of both boxes.

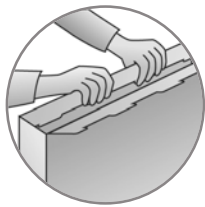

box with image



A T-shaped single "feet"



B T-shaped double "feet"

- 4** Insert rectangular connectors into the top of the standing box.
- 5** Insert 4-tab connectors to attach boxes side by side.
- 6** Use top connectors to keep boxes aligned at the top.



C rectangular single connector

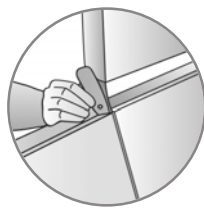

D 4-tab connector

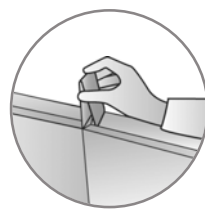

E top connector

Adbox Wall (9 boxes)



CONFIGURATION SAMPLES:

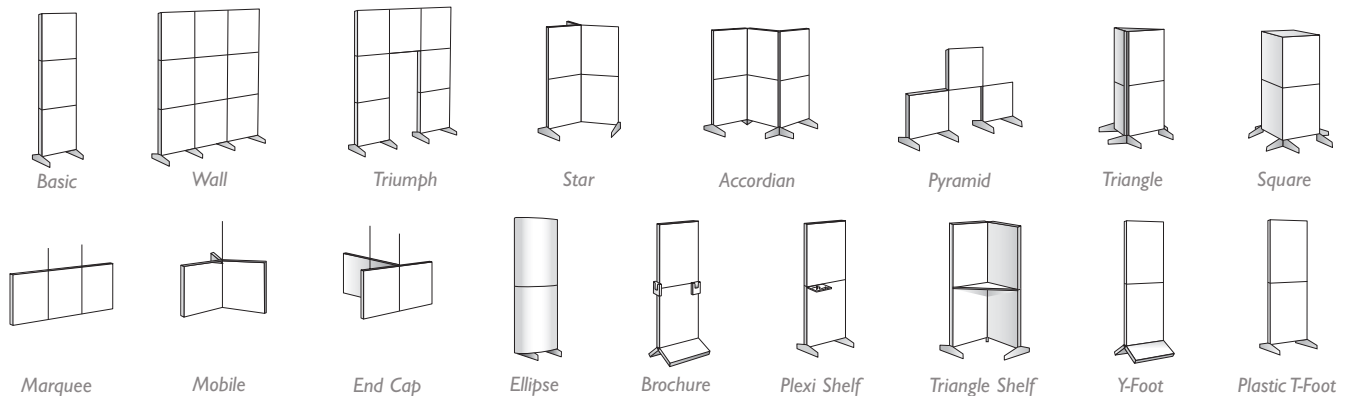

Adbox continues on next page.

ADBOX®

The most versatile display concept in the world is also cost-effective, especially at high volumes. Major audience impact. Flexibility. Cost-effectiveness. It's easy to start something big.

Adbox assembles in a snap, with no tools. It's "goof-proof". And that's smart.



Tower (2 boxes)
w. brochure holders



Triangle



Wall (9 boxes)



Staggered Wall

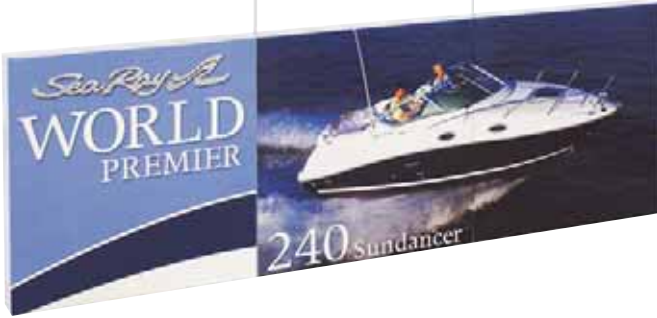

hanging Marquee



hanging Mobile

Tower (3 boxes)

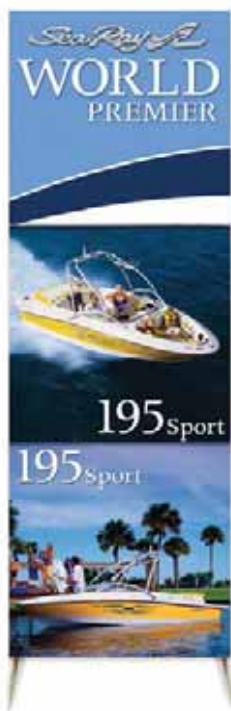

Wall (9 boxes)

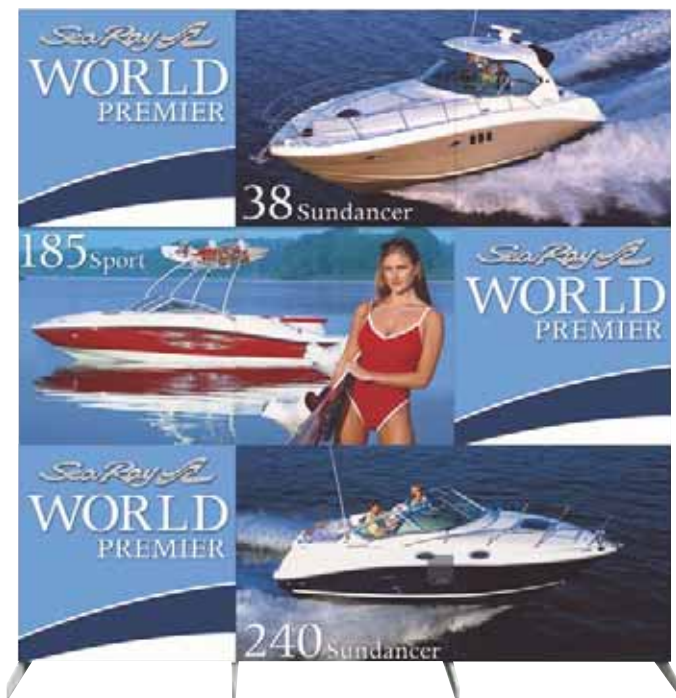

Table-top w. shelves



V-shaped w. shelves



Tower (4 boxes)



Y-Foot Tower



Tower (2 boxes) w. wire feet

Call for the complete Adbox information brochure.

FABRICWALL

From Folded to Fabulous in Seconds.

FabricWall goes from folded to fabulous in 10 seconds flat. The graphic fabric panel comes attached to the frame. Magnetic locks snap the structure into place. All you have to do is pull it up and watch your message burst open. Make it double-sided for maximum impact. The wrinkle-resistant graphic panel attaches to the structure with Velcro so you can swap graphics in a flash. Premium print quality guarantees vibrant visuals every time. And this super-lightweight, super-portable billboard-in-a-bag knocks down into a nylon duffel for easy transport. Make a big statement. Effortlessly.



SPECIFICATIONS

FabricWall, lightweight aluminum, construction with Velcro hubs. Graphic panel not included.

- 39114** 2x3 squares, 59" x 88 5/8" (150 x 225 cm), 11 lbs. (5 kg)
39116 3x3 squares, 88 5/8" x 88 5/8" (225 x 225 cm), 16 lbs. (7.3 kg)
39118 4x3 squares, 118" x 88 5/8" (300 x 225 cm), 21 lbs. (9.6 kg)
39120 4x4 squares, 118" x 118" (300 x 300 cm), 26 lbs. (11.8 kg)
 (4x4 requires 2 Support Feet # 39107)

Double-sided and other sizes also available upon request

Base material: Grey Painted Aluminum

Graphic panel: Dye-sublimation on wrinkle resistant fabric

Packaging: Carton Box or optional Bag

OPTIONAL PARTS & ACCESSORIES

- 36300** Carrying Case, Small (for 2x3 size only), Black Nylon
36301 Carrying Case, Large, Black Nylon
36400 Quick Connect Spotlight 200 W
39107 Support Foot

The FabricWall structure builds on a "Square" system. Each square is 29 1/2" x 29 1/2" (75 cm x 75 cm). Depth of frame is 11 3/4" (30 cm).

Select the size best suited for your needs.



2 x 3

59" x 88 5/8"

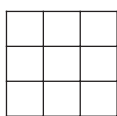

3 x 3

88 5/8" x 88 5/8"

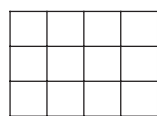

4 x 3

118" x 88 5/8"

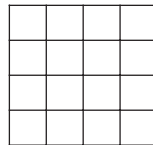

4 x 4

118" x 118"

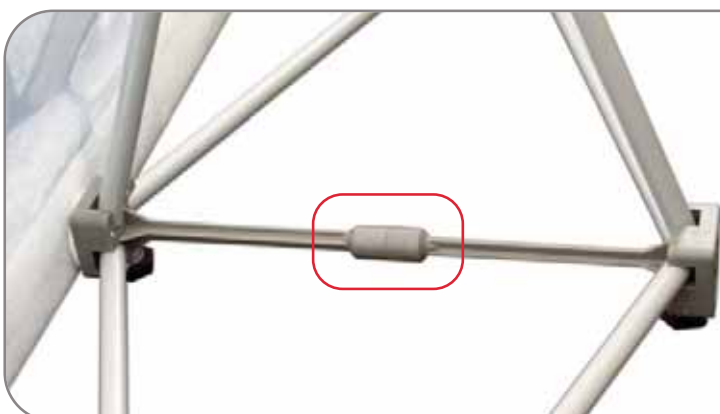
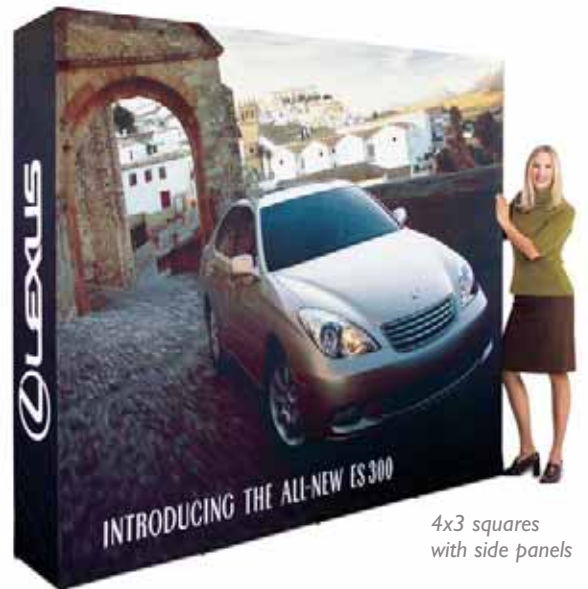
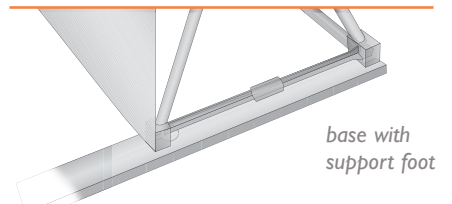

MAGNETIC LOCKING SYSTEM:

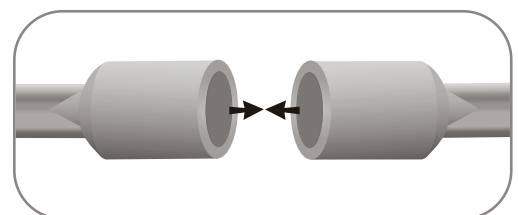

FABRICOUNTER

Easy Setup, Easy Display.

Turn the tables with FabriCounter. This easy to set-up, compact display does double duty: use it as a table-top display or add a top shelf to turn it into a counter. The frame snaps together in an instant with magnetic locks. Velcro tape makes switching the wrinkle-resistant fabric graphic panel quick and easy. Need to make a bigger statement? Join units side-by-side to create a counter-table. This lightweight, portable system packs neatly into its own durable reinforced nylon bag.

However you configure it, this simple display tool gets your message on the table.



SPECIFICATIONS

FabriCounter, lightweight aluminum, construction with Velcro hubs. Graphic panel and top shelf not included.

39340 FabriCounter, 34 5/8" W. x 34 5/8" H. x 12" D.
(88 W. x 88 H. x 30.5 D. cm)

Weight: 2 lbs. (0.9 kg)

Base material: Grey Painted Aluminum

Graphic panel: Dye-sublimation on wrinkle resistant fabric

Packaging: Reinforced Nylon Canvas Bag or Carton Box

OPTIONAL PARTS & ACCESSORIES

39349 Top Shelf, Grey, 36" x 13 1/4" (91.5 x 34 cm), 7 lbs.
(3.2 kg), packed in the carton box

39264 Nylon bag, Padded, Black

39349



39264



COMBINATIONS WITH OTHER PRODUCTS:



with FabricWall



with Pop-It-Up



The fabric is attached to the hub of the frame by Velcro tape.

APPLICATIONS:

Place the FabriCounter on top of a table to make it a **table-top display**.



Add a top shelf on top of the FabriCounter to make it a **counter-table**.



Velcro tape attached to the top shelf

Velcro tape attached to the fabric



MAGNETIC LOCKING SYSTEM:

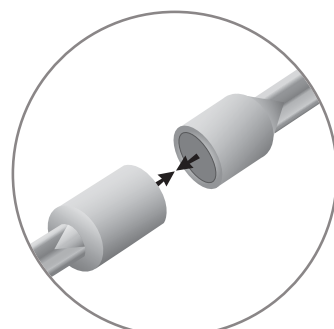

STRETCHWALL

Come Forward.

Stretch your imagination with this inventive, versatile display. Choose from a multitude of combinations, then let the fun begin. Arrange panels in novel ways, in 3D. Change your message by changing the panel. The button fastening system makes it easy to play around. Its lightweight magnetic lock frame lets it collapse easily, without needing to remove graphic panels. StretchWall is accessory-friendly. Make it functional by adding a display shelf. Attach a spotlight to a configuration with a flat horizontal top. Highly portable, this display system travels in its own chic black nylon bag.

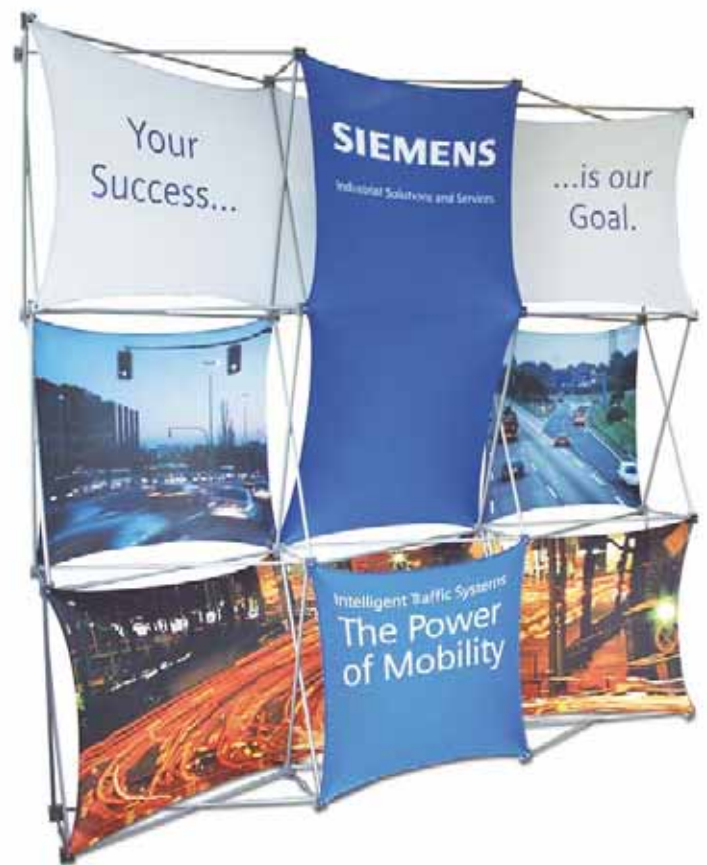

SPECIFICATIONS

StretchWall, lightweight aluminum construction, painted in grey. Incl. hubs with buttons. Graphic panels and top shelf not included.

Double-sided and other configurations also available. Please ask about various configuration numbers.

Base material: Grey Painted Aluminum

Graphic panel: Dye-sublimation on stretch fabric

Packaging: Carton Box or optional Bag

OPTIONAL PARTS & ACCESSORIES

- 36430** Shelf, Clear Anodized Aluminum
- 36300** Carrying Case, Small, Black Nylon
- 36301** Carrying Case, Large, Black Nylon
- 36303** SoftCase w. wheels (see p. 56)
- 36400** Quick Connect Spotlight 200 W
- 39107** Support Foot (on certain configurations only)

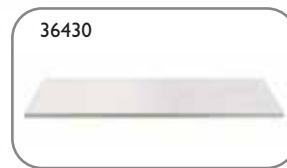
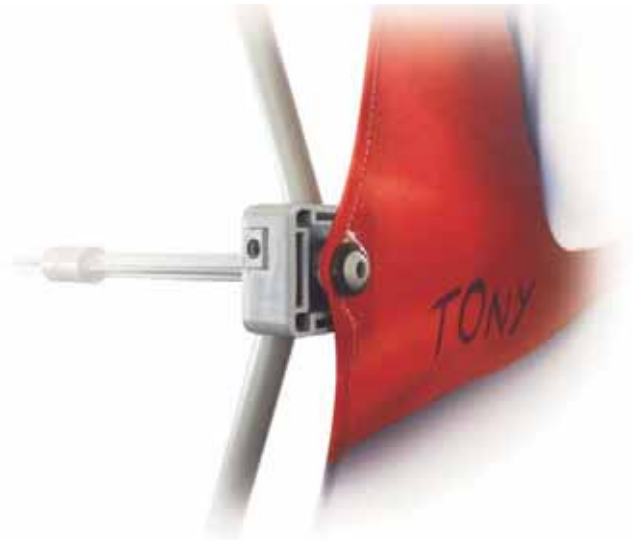

SAMPLE CONFIGURATIONS:



103



206



501



204



301



502



205



405

APPLICATION OPTIONS:



On certain configurations, you can add a spotlight or display shelf to make a multi-functional display unit.

BUTTON FASTENING SYSTEM:

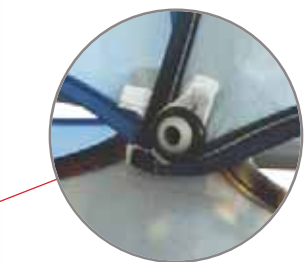

Stretch the graphic fabric and fasten it to the button-knob of the frame construction. One button-knob can hold up to four pieces of graphic fabric.

Call for StretchWall configuration brochure.

ROLL-IT-UP 4

reddot design award
winner 2006



Form and Function in Perfect Harmony.

The next generation of retractable display. The top bar and the base unit of this system disappear behind your graphic so customers see all banner, no banner stand. The stylish construction, from top to the sleek oval foot, has a uniquely sparkling finish that's as durable as it is attractive. A spring-loaded roller mechanism lets you adjust the tension if the need arises. Line up several displays for a powerful impression. The patented system folds into a tidy package in its own sturdy, chic nylon bag. It's lightweight so it's easy to ship.

Function. Style. Portability. All rolled into one superior display.





SPECIFICATIONS

Complete Roll-It-Up 4 unit, single-sided, incl. padded nylon bag w. shoulder strap. Graphic panel not included.

Standard visual graphic sizes:

- 39050** Silver Painted, 33 1/2" x 74 13/16" (85 x 190 cm)
- 39051** Silver Painted, 33 1/2" x 82 11/16" (85 x 210 cm)
- 39052** Silver Painted, 33 1/2" x 90 9/16" (85 x 230 cm)
- 39055** Silver Painted, 39 3/8" x 74 13/16" (100 x 190 cm)
- 39053** Silver Painted, 39 3/8" x 82 11/16" (100 x 210 cm)
- 39054** Silver Painted, 39 3/8" x 90 9/16" (100 x 230 cm)

Weight: 9 lbs. (4 kg) or 11 lbs. (5 kg)

Base panel: Painted Aluminum

Graphic panel: Several options available

Packaging: Reinforced Nylon Canvas Bag

OPTIONAL PARTS & ACCESSORIES

- 39074** Top Profile, Clear Anodized, 33 1/2" (85 cm)
- 39076** Top Profile, Clear Anodized, 39 3/8" (100 cm)
- 39060** Pole, 3-folded, Clear Anodized, for panel 74 13/16" (190 cm)
- 39062** Pole, 3-folded, Clear Anodized, for panel 82 11/16" (210 cm)
- 39064** Pole, 3-folded, Clear Anodized, for panel 90 9/16" (230 cm)
- 39087** Nylon Bag, Padded, Black, for 39 3/8" unit
- 39088** Nylon Bag, Padded, Black, for 33 1/2" unit
- 39085** Halogen Spotlight, 12V/50 W, w. transformer

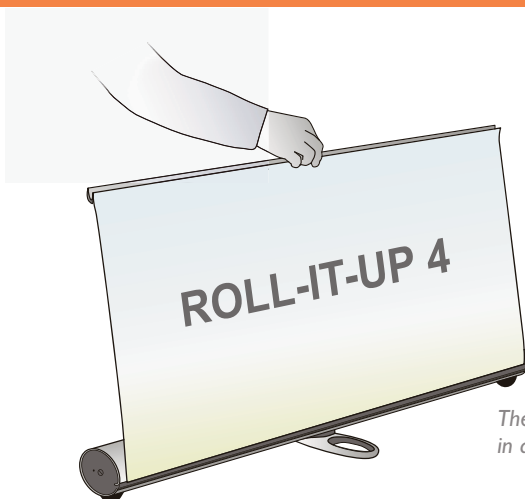
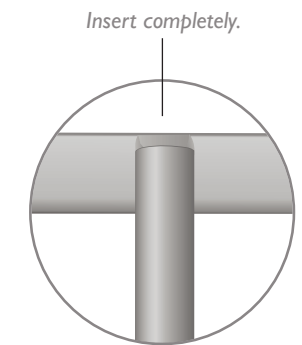
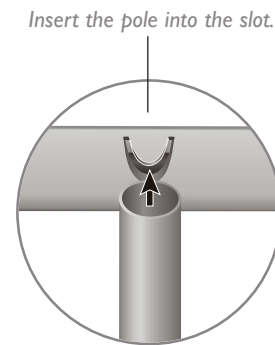
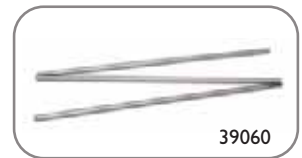

The graphic panel rolls in and out of the unit.



Roll-it-up 4 can even be used at various heights. By simply extending the pole to only 1/3 or 2/3 of its full length, you can quickly create a presentation in stages or a table-top display.

ROLL-IT-UP 1

Ready to Roll.

The structured aluminum base of this classic display acts as a protective housing for your graphic panel so your image stays in perfect condition. The swivel kickstand adds stability but not bulk. All seven feet roll into the base for a flat package that fits neatly into a slim padded nylon carrying case. Robust construction coupled with portability helped this tool become the workhorse of retractable displays.



SPECIFICATIONS

Complete Roll-It-Up 1 unit with padded carrying bag. Graphic panel not included.

Standard visual graphic sizes:

- 39001** Clear Anodized, 33 1/2" x 79" (85 x 200 cm)
- 39002** Clear Anodized, 33 1/2" x 86" (85 x 218 cm)
- 39003** Clear Anodized, 39 3/8" x 79" (100 x 200 cm)
- 39004** Clear Anodized, 39 3/8" x 86" (100 x 218 cm)

Weight: 11 lbs. (5 kg) or 13 lbs. (6 kg)

Base material: Clear Anodized Aluminum

Graphic panel: Several options available

Packaging: Reinforced Nylon Canvas Bag

OPTIONAL PARTS & ACCESSORIES

- 39010** Top Profile, Snap-action w. Hook, Clear Anodized, 33 1/2" (85 cm)
- 39012** Top Profile, Snap-action w. Hook, Clear Anodized, 39 3/8" (100 cm)
- 39021** Pole, 3-folded, Clear Anodized, 79" (200 cm)
- 39020** Pole, 3-folded, Clear Anodized, 86" (218 cm)
- 39263** Nylon bag, Padded, Black, for 33 1/2" unit
- 39264** Nylon bag, Padded, Black, for 39 3/8" unit
- 39269** Halogen Spotlight 50 W w. transformer incl. bag



39010



39021



39263



39269

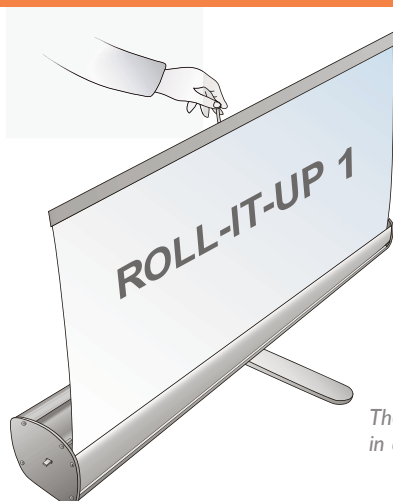

The graphic panel rolls in and out of the unit.



Roll-it-up 1 can even be used at various heights. By simply extending the pole to only 1/3 or 2/3 of its full length, you can quickly create a presentation in stages or a table-top display.

ROLL-IT-UP 3

Swap and Roll.

Be a quick-change artist. This innovative banner stand features interchangeable graphic cassettes that let you swap messages. Better yet, the pole works at three heights to allow you to go from counter to floor display in a snap. A custom trim to match your corporate identity pulls it all together. And it packs neatly into a smart, padded nylon bag so you're always ready to roll with it.





SPECIFICATIONS

Complete Roll-It-Up 3 unit w. interchangeable cassette and padded nylon carrying bag. Graphic panel not included.

Standard visual graphic sizes:

- 39510** Clear Anodized w. grey plastic trim, 33 1/2" x 79" (85 x 200 cm)
- 39520** Clear Anodized w. grey plastic trim, 39 3/8" x 79" (100 x 200 cm)
- 39530** Clear Anodized w. grey plastic trim, 33 1/2" x 86" (85 x 218 cm)
- 39540** Clear Anodized w. grey plastic trim, 39 3/8" x 86" (100 x 218 cm)

Weight: 13 lbs. (6 kg) or 15 lbs. (7 kg)

Base material: Clear Anodized Aluminum

Graphic panel: Several options available

Packaging: Reinforced Padded Nylon Bag



Grey trim set is standard. Red, Blue, and Green are extra accessories.

OPTIONAL PARTS & ACCESSORIES

- 39601** Cassette incl. Snap-action Top Profile, 33 1/2" (85 cm)
- 39611** Cassette incl. Snap-action Top Profile, 39 3/8" (100 cm)
- 39231** Pole, 3-folded, Clear Anodized, 79" (200 cm)
- 39241** Pole, 3-folded, Clear Anodized, 86" (218 cm)
- 39621** Plastic Trim Set, 33 1/2" (85 cm), Grey
- 39625** Plastic Trim Set, 33 1/2" (85 cm), Red
- 39626** Plastic Trim Set, 33 1/2" (85 cm), Blue
- 39628** Plastic Trim Set, 33 1/2" (85 cm), Green
- 39631** Plastic Trim Set, 39 3/8" (100 cm), Grey
- 39635** Plastic Trim Set, 39 3/8" (100 cm), Red
- 39636** Plastic Trim Set, 39 3/8" (100 cm), Blue
- 39638** Plastic Trim Set, 39 3/8" (100 cm), Green
- 39351** Halogen Spotlight 50 W w. transformer, Grey
- 39490** Nylon Bag, Padded, Black, for 33 1/2" unit
- 39492** Nylon Bag, Padded, Black, for 39 3/8" unit



Interchangeable cassette



39621



39601



39351



39231



39490

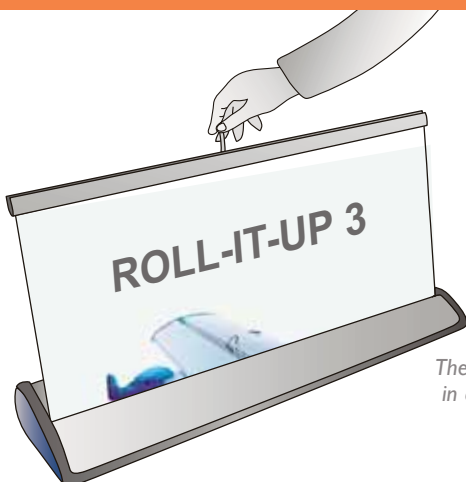

The graphic panel rolls in and out of the unit.



Roll-it-up 3 can even be used at various heights. By simply extending the pole to only 1/3 or 2/3 of its full length, you can quickly create a presentation in stages or a table-top display.

IMAGESTAND 1

reddot design award
winner 2006



More Image. More Impact.

Use it once or use it for a long time.
This non-retractable banner stand gets great mileage in a POP or retail scenario. Its sleek fish-shaped foot is made of cast aluminum to give your message gravity. And its special lacquer finish makes it durable. A protective cylinder in the optional travel bag keeps your visuals clean. Put two or more together for a high-impact presentation. This is the cost-effective solution that lets your images stand for themselves.



SPECIFICATIONS

ImageStand 1, bag and graphic panel not included.

Standard visual graphic sizes (or pick and choose the combination with parts listed below):

- 39100** Silver Painted, 23 5/8" x 85" (60 cm x 216 cm)
- 39102** Silver Painted, 31 1/2" x 85" (80 cm x 216 cm)
- 39104** Silver Painted, 39 3/8" x 85" (100 cm x 216 cm)

Weight: 7 lbs. (3.2 kg)

Base material: Silver Painted Aluminum

Graphic panel: Several options available

Packaging: Re-usable Carton Box w. protective space for the graphic panel, Nylon Bag optional

OPTIONAL PARTS & ACCESSORIES

39094 Foot only

39097 Top Extrusion adapter

39070 Top/Bottom Profile Set, Clear Anodized, 23 5/8" (60 cm)

39072 Top/Bottom Profile Set, Clear Anodized, 31 1/2" (80 cm)

39076 Top/Bottom Profile Set, Clear Anodized, 39 3/8" (100 cm)

39060 Pole, 3-folded, for panel height 77 1/8" (196 cm)

39062 Pole, 3-folded, for panel height 85" (216 cm)

39064 Pole, 3-folded, for panel height 93 5/16" (237 cm)

39081 Nylon Bag, Padded, Black, for 23 5/8 & 31 1/2" units

39082 Nylon Bag, Padded, Black, for 39 3/8" unit

39085 Halogen Spotlight 50 W w. transformer, Grey



20/2

IMAGESTAND 1



39094



39070



39097



39085

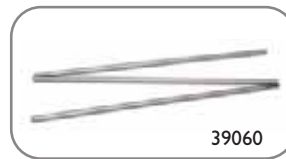

39060



39081

Pole with extrusion adapter is connected to top profile.



Foot is connected to bottom profile.



IMAGESTAND 2

reddot design award
winner 2006



Stand Up. Stand Out.

Command attention. Do something unexpected. This image stand is customizable in three ways: height, width and shape. It uses horizontal rods that can be custom-cut to your specs to let you display unusual contours. Make it tall and thin, short and fat, or even V-shaped? The slick tripod foot keeps it stable no matter the configuration and folds for maximum portability. Its optional carrying case was designed to protect graphics.

Imagestand 2 goes from single to double-sided with a simple snap-clip. The top and bottom bars disappear so your message always takes center stage.



SPECIFICATIONS

ImageStand 2, bag and graphic panel not included.

Standard visual graphic sizes (or pick and choose the combination with parts listed below):

- 39121** Silver Painted, 23 5/8" x 82 11/16" (60 x 210 cm)
- 39123** Silver Painted, 31 1/2" x 82 11/16" (80 x 210 cm)
- 39125** Silver Painted, 39 3/8" x 82 11/16" (100 x 210 cm)

Weight: 7 lbs. (3.2 kg)

Base material: Silver Painted Aluminum

Graphic panel: Several options available

Packaging: Re-usable Carton Box w. protective space for the graphic panel, Nylon Bag optional

OPTIONAL PARTS & ACCESSORIES

- 39130** Foot only, foldable
- 39132** Plastic Clip for single & double-sided
- 39060** Pole, 3-folded, for panel 74 13/16" (190 cm)
- 39062** Pole, 3-folded, for panel 82 11/16" (210 cm)
- 39064** Pole, 3-folded, for panel 90 9/16" (230 cm)
- 39070** Top/Bottom Profile Set w. tape, Clear Anodized, 23 5/8" (60 cm)
- 39072** Top/Bottom Profile Set w. tape, Clear Anodized, 31 1/2" (80 cm)
- 39076** Top/Bottom Profile Set w. tape, Clear Anodized, 39 3/8" (100 cm)
- 39083** Nylon Bag, Padded, Black, for 23 5/8" & 31 1/2" units
- 39084** Nylon Bag, Padded, Black, for 39 3/8" unit
- 39085** Halogen Spotlight 50 W w. transformer, Grey

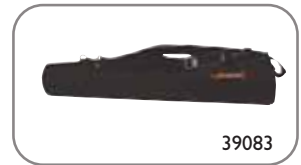
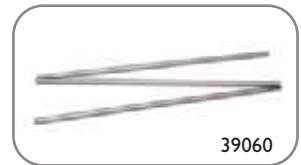

Choose Panel Size:

Max. width 39 3/8" (100 cm), max. height 90 9/16" (230 cm)

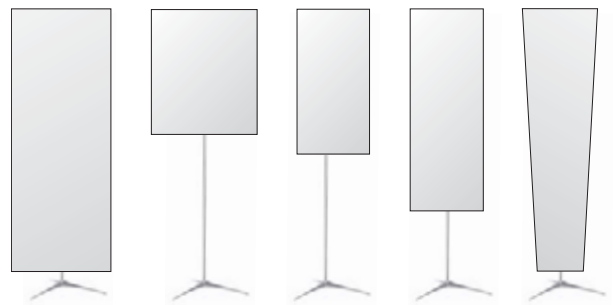

Insert the pole into the slot.

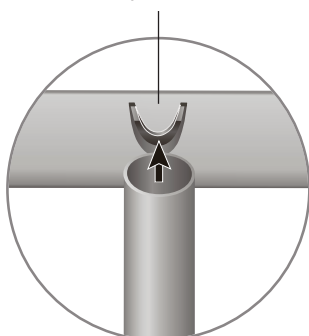

Insert completely.

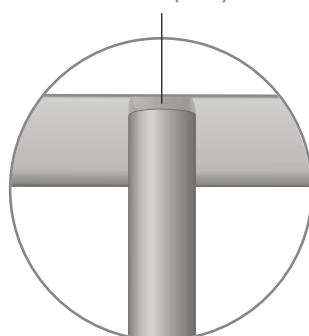

extra clip for double-sided graphics



ADAPT

A Simple Solution.

Just the basics, please. This cost-effective image stand adapts to a variety of print media – from inkjet to vinyl to fabric. It comes with its own nylon travel bag and PVC-reinforced graphic tube for safe and easy transport, while its x-shaped aluminum swivel stand folds flat. Make it double-sided when you really need to work the room or customize the shape of the graphic panel for a unique touch. Combine several for a first-class performance. It's simply effective.





SPECIFICATIONS

Adapt, complete unit, single or double-sided, incl. black nylon bag.
Graphic not included.

Standard visual graphic size:

39140 Clear Anodized, 24" x 72" (61 x 183 cm)

Weight: 6 lbs. (2.7 kg)

Cross Base: Clear Anodized Aluminum

Graphic panel: Several options available

Packaging: Black Nylon Bag with PVC-reinforced graphic tube

REPLACEMENT PARTS

- 37011** Cross Base, Clear Anodized Aluminum
- 37131** Vertical Pole, 3 sections, Clear Anodized Aluminum, 75" (190.5 cm)
- 37231** Horizontal Bars, set of 2, w. double-sided tape & endcaps, Aluminum, Clear Anodized, 24" (61 cm)
- 37311** Snap-Clip, single-sided, Grey, Plastic
- 37321** Snap-Clip, double-sided, Grey, Plastic
- 37410** Nylon Bag, Black

Choose Panel Size:

Max. width 24" (61 cm), max. height 72" (183 cm)

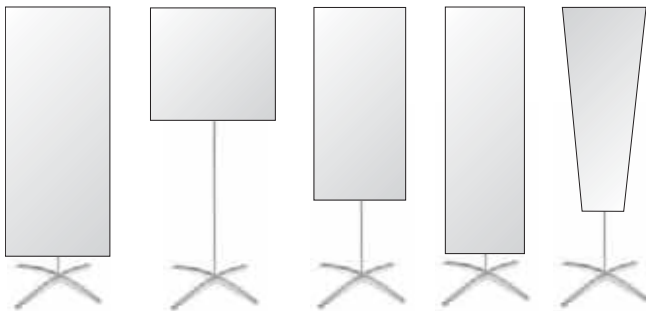

graphic with customized cup shape



37011

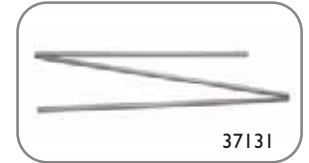

37131



37311



37321

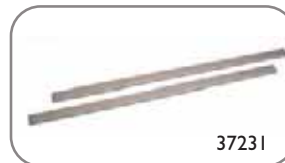

37231



37410



The single-sided unit Snap-Clip #37311 is used to connect the top and bottom horizontal bars to the vertical pole.



To convert the single-sided unit into a double-sided, use Snap-Clip #37321 and place over the single clip.



POP-IT-UP

For Major Impact, Pop-It-Up!

Stir up some excitement with this curvy display. Lightweight and portable, this innovative system sets up as easy as 1-2-3. First, simply pull open the frame. No hooks, no joints. It's that easy. Second, attach the graphic panel onto the structure with magnet strips. There are no hooks to impede view of your visual composition. Then wrap a graphic panel around its travel case to convert it into a counter. This system has serious curve appeal. Pop-It-Up and present.





SPECIFICATIONS

Pop-It-Up, complete construction with magnetic bars and strips.
TransportCase optional. Graphic panels and Fronrunner not included.

- 44103 8-foot Pop-It-Up, 100 3/8" x 93 5/16" (255 x 237 cm)
- 44104 10-foot Pop-It-Up, 129 15/16" x 93 5/16" (330 x 237 cm)

Base material: Grey Painted Aluminum
Panel: Laminated inkjet print-out, or Fronrunner

OPTIONAL PARTS & ACCESSORIES

- 44111 Top & bottom strips w. hooks, for front panel
- 44112 Top & bottom strips w. hooks, for end panels
- 44115 Top & bottom strips w. hooks, for back panel
- 44113 Panel Hanger
- 44120 Magnetic Bar, 3 folded
- 46100 TransportCase w. wheels (see p. 55)
- 46110 Top Shelf for TransportCase, Grey
- 46111 Top Shelf for TransportCase, Black
- 46115 Wrap for TransportCase, Fronrunner, Black

- 36400 Quick Connect Spotlight 200 W, Black

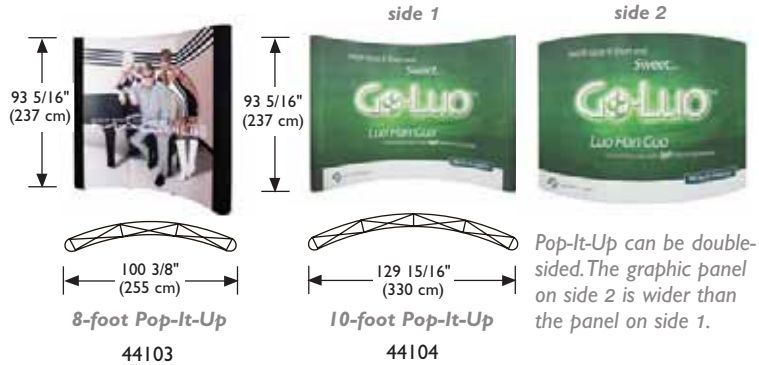

MAGNETIC LOCKING SYSTEM:

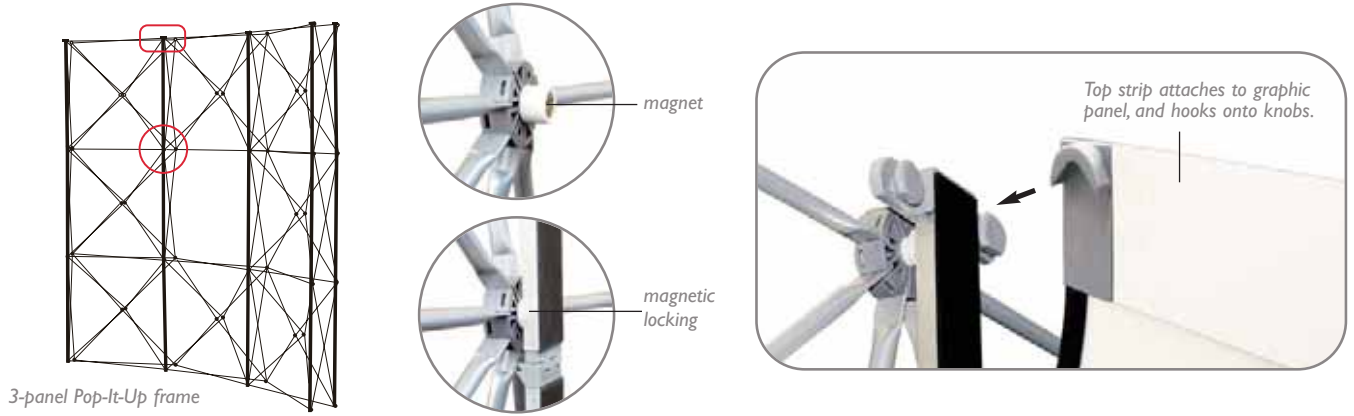

3-panel Pop-It-Up frame

QUIKFRAME

Make a Snap Decision.

It's an open and shut case. QuikFrame's c-spring clips snap open on all four sides for swift and effortless graphic changes. Hang it or attach it to a freestanding display. There are many options with QuikFrame. Pick a size. Go standard and choose a rounded or mitered corner. You can customize it to your dimensions and choose a special finish or colour. Double-side it for twice the impact. It's so very versatile. Wherever there's a poster, there's a need for QuikFrame.





SPECIFICATIONS

QuikFrame with mitered or rounded corners. Aluminum in Clear Anodized (code-1) or Black Painted (code-3).

Standard sizes:

- 3008-?** 8 1/2" x 11" poster size, **mitered** corner
- 3011-?** 11" x 17" poster size, **mitered** corner
- 3020-?** 20" x 24" poster size, **mitered** corner
- 3022-?** 22" x 28" poster size, **mitered** corner
- 3025-?** 24" x 36" poster size, **mitered** corner
- 3030-?** 30" x 40" poster size, **mitered** corner
- 3036-?** 36" x 48" poster size, **mitered** corner

- 3108-?** 8 1/2" x 11" poster size, **rounded** corner
- 3111-?** 11" x 17" poster size, **rounded** corner
- 3120-?** 20" x 24" poster size, **rounded** corner
- 3122-?** 22" x 28" poster size, **rounded** corner
- 3125-?** 24" x 36" poster size, **rounded** corner
- 3130-?** 30" x 40" poster size, **rounded** corner
- 3136-?** 36" x 48" poster size, **rounded** corner

Customized sizes and finishes available

OPTIONAL PARTS & ACCESSORIES

- 34010** Easel for size 8 1/2" x 11" only
- 34020** Eyelet Hook
- 34030** Slatwall Hook
- 34040** Z-bar for wall hanging
- 31501** Non-glare protection sheet, 8 1/2" x 11"
- 31511** Non-glare protection sheet, 11" x 17"
- 31561** Non-glare protection sheet, 20" x 24"
- 31581** Non-glare protection sheet, 22" x 28"
- 31621** Non-glare protection sheet, 24" x 36"
- 31641** Non-glare protection sheet, 30" x 40"
- 31661** Non-glare protection sheet, 36" x 48"

Standard finishes and colours for mitered or rounded corners:

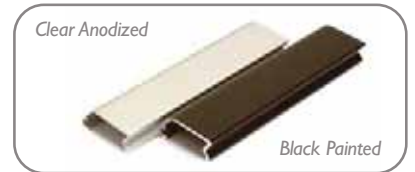

Other finishes and colours can be customized.

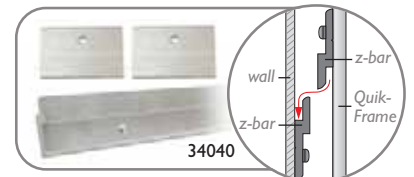
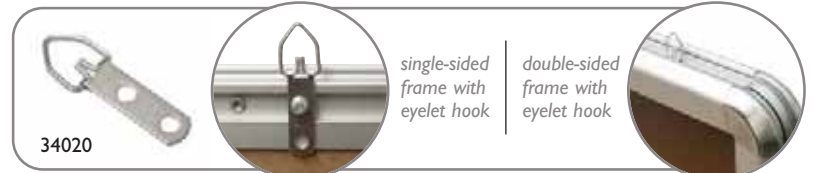
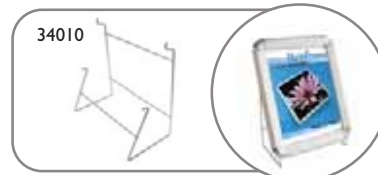

Standard frame with back panel:

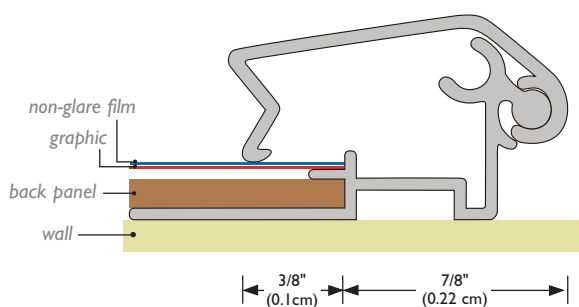

Optional bottom flat wall extrusion w/o back panel (only for mitered corners):

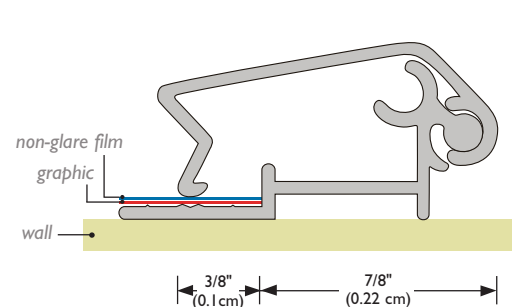

QUIKFRAME

MOST COMBINATIONS AND USES CAN BE APPLIED TO INFRAME.

QUIKFRAME CAN BE WIDELY APPLIED:

QuikFrame. Endless combinations and uses. Mount it on walls, windows, even vehicles. Spark some interest. Use it with a lightbox. Precision-punched holes on the back of the frame line up perfectly so connecting two frames for double-sided display is easy. Look around for inspiration. This frame integrates seamlessly with a multitude of display tools. With such versatility, QuikFrame has many sides.



as information board

for slatwall



3-Frame



A-Frame



on PosterStand



on LightBox



on wall



as hanging sign



on Tripod



on PosterStand



on PosterStand



on InfoStand

INFRAME

Reframe the Issue.

Innovative and customizable, this tool emphasizes your brand message, all the way around. Its patented design allows you to easily slide your message into the frame edges and change it as often as you wish. Use it to update information or reinforce your brand identity. Go with a custom finish in wood or metal for a stylish, detailed look. The snapframe mechanism holds the center graphic firmly in place until you are ready to swap it. Use it single-sided or double it up for twice the impact.

InFrame. A new frame of reference in poster displays.

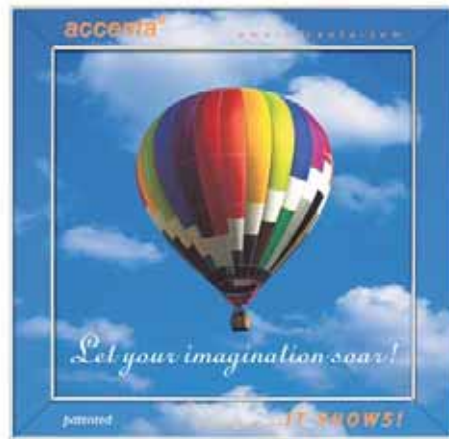

SPECIFICATIONS

InFrame with mitered corners, clear anodized aluminum.

Standard sizes:

- 32001** 11" x 17" poster size, **mitered** corner
- 32003** 20" x 24" poster size, **mitered** corner
- 32005** 22" x 28" poster size, **mitered** corner
- 32007** 24" x 36" poster size, **mitered** corner
- 32009** 30" x 40" poster size, **mitered** corner
- 32011** 36" x 48" poster size, **mitered** corner

Customized sizes and other colours available

OPTIONAL PARTS & ACCESSORIES

- 34020** Eyelet Hook
- 34030** Slatwall Hook
- 34040** Z-bar for wall hanging
- 31511** Non-glare protection sheet, 11" x 17"
- 31561** Non-glare protection sheet, 20" x 24"
- 31581** Non-glare protection sheet, 22" x 28"
- 31621** Non-glare protection sheet, 24" x 36"
- 31641** Non-glare protection sheet, 30" x 40"
- 31661** Non-glare protection sheet, 36" x 48"

InFrame accepts slide-in graphics in a multitude of substrates, incl. laminate in wood grain and other patterns. Slide-in graphics is 2" (5.1 cm) in width and a thickness of 0.05" (1 mm).

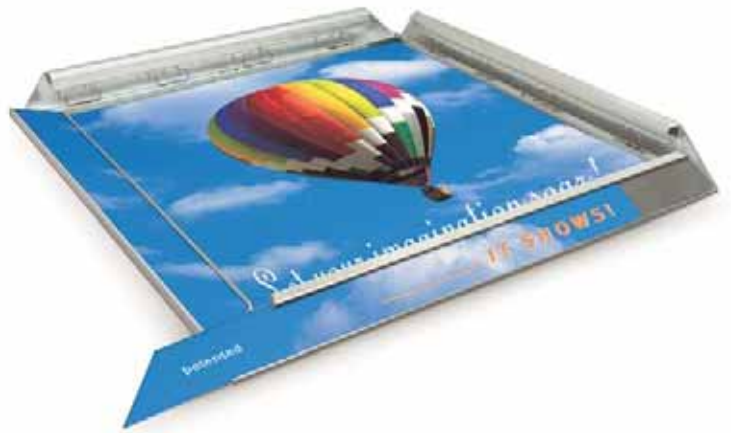
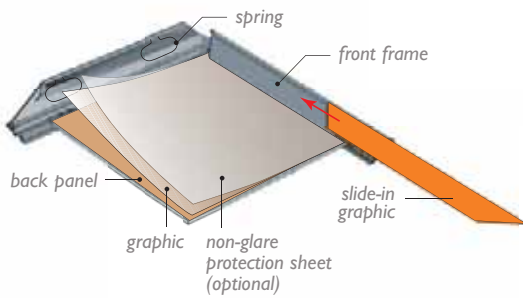

InFrame can be as widely applied as QuikFrame. For more applications, please see p. 30-31.

31501-31661

34030

34020

single-sided frame with eyelet hook | double-sided frame with eyelet hook

34040

wall, z-bar, In-Frame

Frame closed:

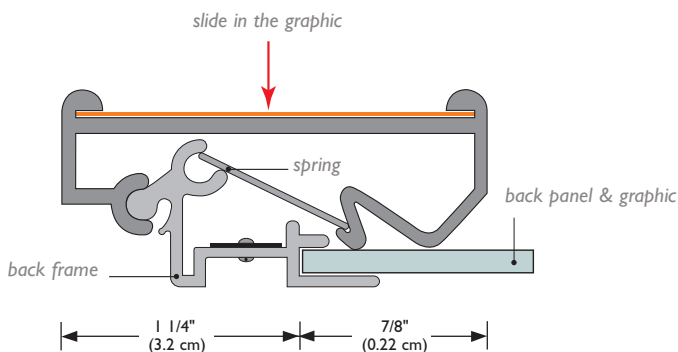

Frame open:

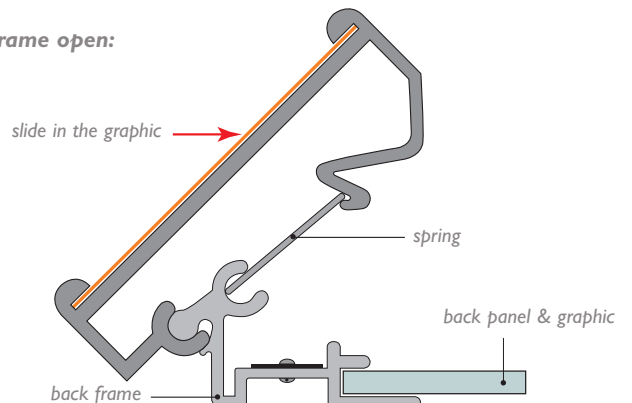

TRIMLITE

A Bright Concept.

Get enlightened with this new generation of graphic light panels. Ultra-thin design. Edge-housed lighting to minimize hot spots and give bright, even illumination. Do-it-yourself maintenance and quick-change bulbs add value and convenience. And the easy-loading snapframe makes changing graphics a breeze. Use single-sided or double – it's up to you. TrimLite. Illuminate your ideas.





SPECIFICATIONS

TrimLite with mitered corners only, clear anodized aluminum. Double-sided also available. Built-in T-5 lamp, UL and CSA approved, incl. 10 feet cord w. wall plug.

Standard sizes:

- 32601** 20" x 24" poster size, **mitered** corner
- 32603** 22" x 28" poster size, **mitered** corner
- 32605** 24" x 36" poster size, **mitered** corner
- 32607** 30" x 40" poster size, **mitered** corner
- 32609** 36" x 48" poster size, **mitered** corner

Customized sizes and finishes available

OPTIONAL PARTS & ACCESSORIES

- 34021** Eye Bolt
- 34040** Z-bar for wall hanging
- 31561** Non-glare protection sheet, 20" x 24"
- 31581** Non-glare protection sheet, 22" x 28"
- 31621** Non-glare protection sheet, 24" x 36"
- 31641** Non-glare protection sheet, 30" x 40"
- 31661** Non-glare protection sheet, 36" x 48"

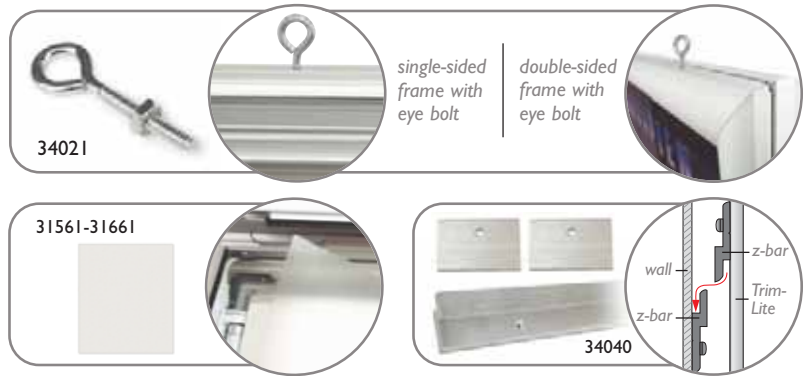

T-5 lamps, with 20,000 hrs. of estimated life, are installed vertically on both sides of the frame. The graphics are placed between the acrylic underneath and the optional non-glare protection sheet on the top.

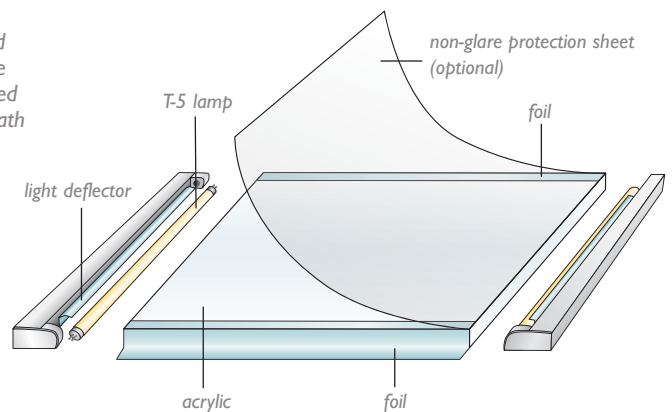

LIGHTBOX

A Brilliant Idea!

Shed some light on the matter with this classic lightbox. QuikFrame (p.28-31) on the front makes it easy to change graphics. Use vinyl, lambda, inkjet prints or transparencies. Its thin T-5 fluorescent tubes create a brilliant even light. Even double-sided. Let your message shine through.

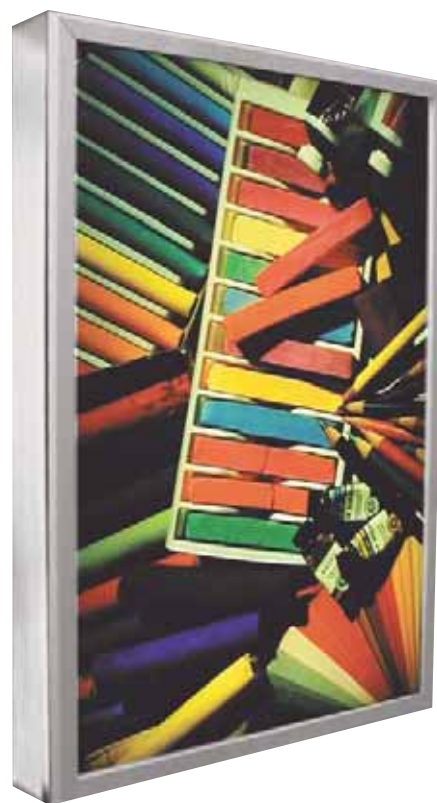

SPECIFICATIONS

LightBox in aluminum housing with QuikFrame front, mitered corners only. 4" in depth. Sign white acrylic covering light fixture of T5-type. UL and CSA approved, incl. 6 feet cord w. wall plug.

Standard sizes:

- 33041** LightBox, Clear Anodized, 20" x 24"
- 33051** LightBox, Clear Anodized, 24" x 36"
- 33071** LightBox, Clear Anodized, 36" x 48"
- 33043** LightBox, Black Painted, 20" x 24"
- 33053** LightBox, Black Painted, 24" x 36"
- 33073** LightBox, Black Painted, 36" x 48"

OPTIONAL PARTS & ACCESSORIES

- 34021** Eye Bolt
- 31561** Non-glare protection sheet, 20" x 24"
- 31621** Non-glare protection sheet, 24" x 36"
- 31661** Non-glare protection sheet, 36" x 48"

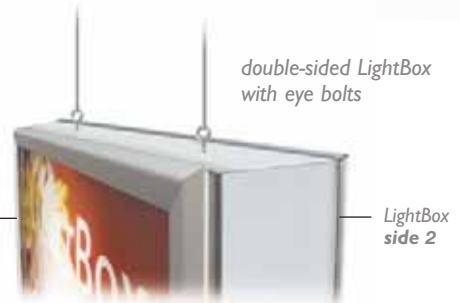

as hanging sign



mounting on the wall



on InfoStand

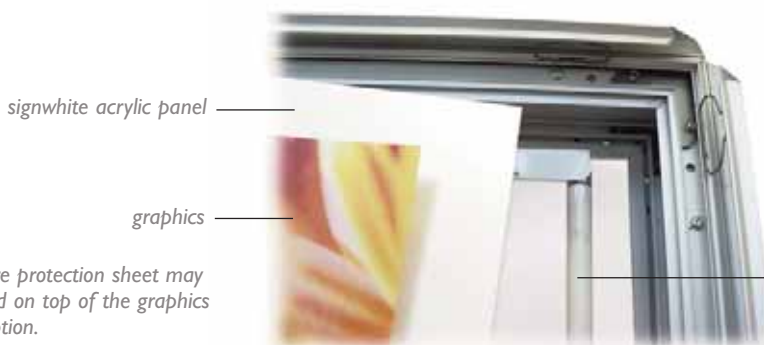

Non-glare protection sheet may be added on top of the graphics as an option.

T-5 lamps, with 20,000 hrs. of estimated life, are installed vertically or horizontally inside of the frame. The graphic is placed on top of the signwhite acrylic.

PLENTYWALL®

Plenty of Impact.

Combinable. Modular. Use PlentyWall as a backdrop or a room divider. Straight or curved, the quick and easy assembly of this display means less time prepping, more time selling. Display a full graphic panel, a header or several banners. Its height-adjustable horizontal bar makes it possible. Takes any graphic, from fabric to vinyl to inkjet. Want more flair? Use the accessory light to create drama or add a brochure shelf for greater functionality. There's plenty of uses for PlentyWall.





SPECIFICATIONS

PlentyWall, construction in clear anodized aluminum, weighted base in dark grey paint. Graphic panel not included, available in laminated inkjet, fabric or vinyl.

- 47001 PlentyWall, curved combination, complete hardware kit
- 47003 PlentyWall, straight combination, complete hardware kit

OPTIONAL PARTS & ACCESSORIES

- 47100 Decor Cap, round, 3 3/4" (9.5 cm) diam. x 2 5/16" (6 cm) H.
- 47019 Vertical Post, Straight, 78 3/4" (200 cm)
- 47013 Horizontal bar, Straight, 68" (172.7 cm)
- 47011 Horizontal bar, Curve, 68" (172.7 cm)
- 47102 Base, steel, round, 20" (50.8 cm) diam. x 1/4" (0.6 cm) H.
- 47109 Halogen Spotlight 20 or 50 W w. transformer, Silver

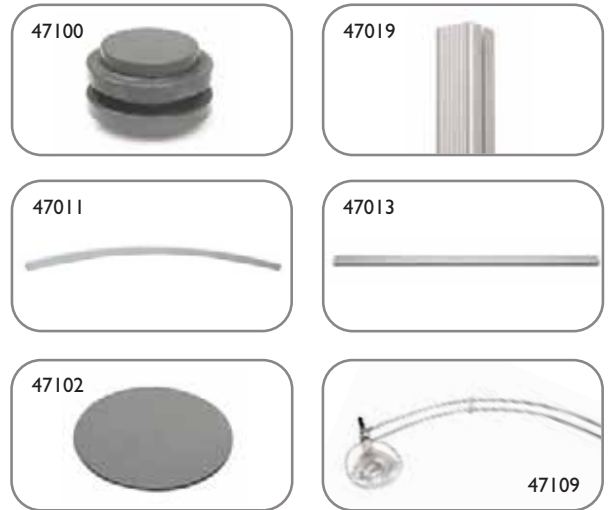

VARIATION OF PLENTYWALL:



curved PlentyWall w. 2 graphic panels & 1 solid panel in between



curved PlentyWall w. 3 solid panels



straight PlentyWall w. logo panel on the top



triple curve



wave-shaped

straight PlentyWall

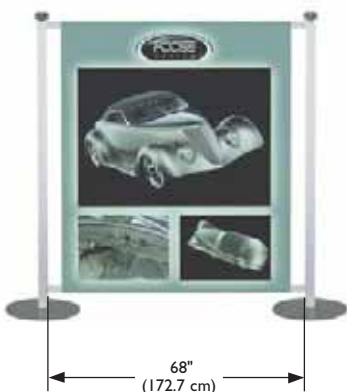

curved PlentyWall



Call for PlentyWall configuration brochure.

INFOSTAND

Take a Stand.

Let your message stand on its own. Turn any QuikFrame (p. 28-31) into a freestanding display. Present a graphic or create a bulletin board. Incorporate a whiteboard or a lightbox. Stand out. Customize the shape of the header and add your logo. Choose brochure baskets to get the word out. Opt for casters to move the message to the masses. The hollow construction is reinforced with anodized aluminum flanges so the unit is sturdy yet lightweight. So take a stand.



SPECIFICATIONS

InfoStand, basic unit, single or double-sided, w. QuikFrame(s) & gliders. Aluminum in Clear Anodized (code-1) or Black Painted (code-3).

Standard sizes (single-sided):

- 3328-?** InfoStand w. 1 x QF 22" W. x 28" H., **rounded** corner
- 3330-?** InfoStand w. 1 x QF 24" W. x 36" H., **rounded** corner
- 3336-?** InfoStand w. 1 x QF 30" W. x 40" H., **rounded** corner
- 3348-?** InfoStand w. 1 x QF 22" W. x 28" H., **mitered** corner
- 3340-?** InfoStand w. 1 x QF 24" W. x 36" H., **mitered** corner
- 3346-?** InfoStand w. 1 x QF 30" W. x 40" H., **mitered** corner

Standard sizes (double-sided):

- 3228-?** InfoStand w. 2 x QF 22" W. x 28" H., **rounded** corner
- 3230-?** InfoStand w. 2 x QF 24" W. x 36" H., **rounded** corner
- 3236-?** InfoStand w. 2 x QF 30" W. x 40" H., **rounded** corner
- 3248-?** InfoStand w. 2 x QF 22" W. x 28" H., **mitered** corner
- 3240-?** InfoStand w. 2 x QF 24" W. x 36" H., **mitered** corner
- 3246-?** InfoStand w. 2 x QF 30" W. x 40" H., **mitered** corner

OPTIONAL PARTS & ACCESSORIES

- 32501** Adjustable Feet, set of 4, incl. bushing
- 32511** Casters, set of 4 (2 w. brake), incl. bushing
- 32521** Header Panel. single-sided, incl. horizontal bar, Grey or Black PVC. (Must be included in original order)
- 32522** Header Panel. double-sided, incl. horizontal bar, Grey or Black PVC. (Must be included in original order)
- 32531** Double-sided brochure rack, incl. horizontal bar, Grey wire w. 4 letter-size pockets
- 31581** Non-glare protection sheet, 22" x 28"
- 31621** Non-glare protection sheet, 24" x 36"
- 31641** Non-glare protection sheet, 30" x 40"

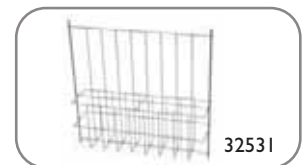
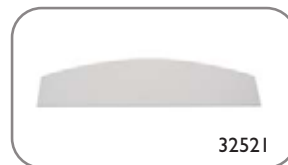
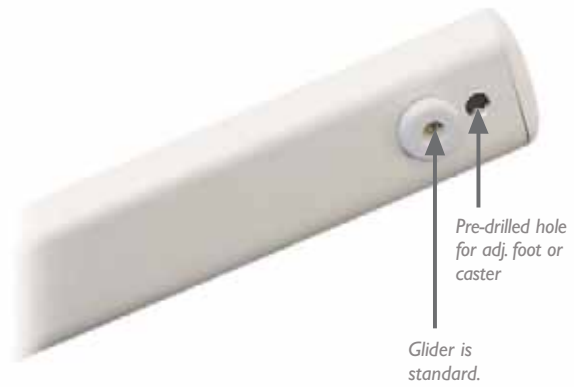

ALTERNATIVE INFO AREA:

As standard, this is a QuikFrame, but could be altered to meet your needs, ie:

- Whiteboard
- Cork board
- Flip pad
- LightBox, etc.

HEADER: Header, consists of PVC panel and Horizontal Bar. Panel(s) attach(es) to Bar with Velcro tape.



POSTERSTAND 1

A Solid Stance.

Customize a self-supporting statement. Use a freestanding image display. The brochure holder of this well-built display makes sure your message gets into the right hands. QuikFrame (p. 28-31) or InFrame (p. 32-33) make changing graphics a snap. Design its base to suit your corporate identity. This unit is no pushover. Its sturdy construction means it'll stand. And deliver.

SPECIFICATIONS

PosterStand 1 on sturdy steel base in silver grey paint. Vertical posts in curved shape and horizontal extrusions in clear anodized aluminum. QuikFrame(s) (p. 28-31) or InFrame(s) (p. 32-33). Brochure holders in clear acrylic.

PosterStand 1 will be fully customized to meet your special requirements.

Please contact us for more information.



For safer transport, base plate and brochure holders need to be attached on site.



POSTERSTAND 2

Stand Tall.

42/4

Got more to say? This customized robust poster stand lets you display two graphics on each side. Its solid build means it'll stay put. QuikFrame (p. 28-31) or InFrame (p. 32-33) make it easy to change visuals. Be creative with your header to brand your logo. Then put it anywhere customers might have to wait. Standing around just got a whole lot more interesting.

SPECIFICATIONS

PosterStand 2 construction in sturdy steel frame mounted on a steel base. Silver grey paint. Double-sided QuikFrame(s) (p. 28-31) or InFrame(s) (p. 32-33). Incl. divider to accommodate 2 posters 24" x 36" per side. Curved or straight header panel in vinyl covered board.

PosterStand 2 will be fully customized to meet your special requirements.

Please contact us for more information.



POSTERSTAND 1 & 2



For safer transport, base plate and header need to be attached on site.



EXSTREAM

Got Hang-Ups?

It's a simple concept that works. And works and works. It lets you hang any graphic, virtually anywhere. Display graphics printed on fabric, paper, vinyl and more. Its strong snap hangers grip various thicknesses so you can make a double-sided display in a cinch. Insert hanging hooks to suspend your visuals from the ceiling. Use suction cups for a window display. Or use Velcro to make your message stick. Hang graphics of any length or width.

Hang it high, hang it low, make it wide, make it thin. It's easy to hang with ExStream.



SPECIFICATIONS

ExStream, top & bottom aluminum snap-profiles w. 4 endcaps & 2 hooks.
Recommended max. thickness of printing media is 0.025".

Standard sizes:

- 3854I** Clear Anodized, L. 24" (61 cm)
- 3855I** Clear Anodized, L. 36" (91 cm)
- 3856I** Clear Anodized, L. 48" (122 cm)

Customized sizes available

OPTIONAL PARTS & ACCESSORIES

- 3850I** Snap-profile Set (front & back extrusions), Clear Anodized Aluminum, max. L. 132" (335 cm)
- 3852I** Endcap, Grey Plastic
- 3853I** Hanging Hook, Grey Plastic



3850I



3852I



3853I



Insert the hanging hooks into top track, and close ends with endcaps.

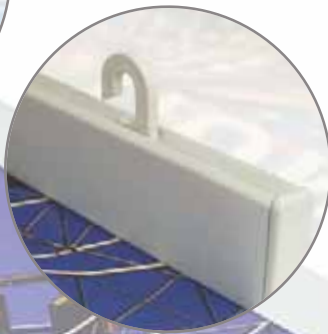

APPLICATIONS:

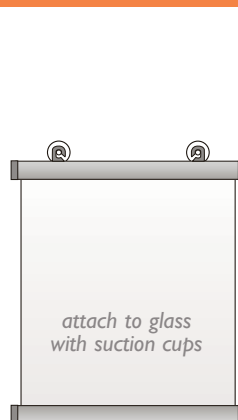
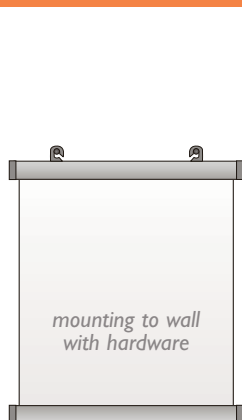
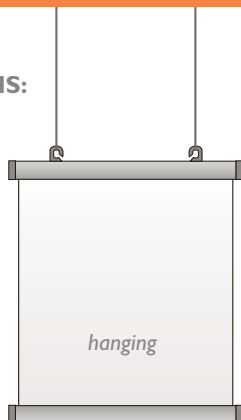

ROUND-UP

360 Degrees of Visual Impact!

Make your message come full circle with Round-Up. Use it as a podium, column, or even a showcase. Make it tall or stout. It is strong enough to be used as a display base. Whatever type of wrap you prefer, it will attach to the robust plates with just magnetic tape. It's as quick to assemble (estimated 30 seconds) as it is easy to exchange panels. Add the optional middle plates to change and elevate the set-up configuration when the need arises. Change its look and function each time you've got something new to say. Round-Up is a tool you can use all year round.



SPECIFICATIONS

Round-Up, set of top and bottom plates in light grey, w. magnetic tape attached. Other colours available. Panel wrap not included.

45610 Set of Top & Bottom Plates, Light Grey, diam. 22" (56 cm)

Wrap: Laminated inkjet, Frontrunner, or transparent substrate, w. magnetic strips on top & bottom edges and Velcro tape to connect wrap vertically. Recommended thickness 0.02-0.03"

Plate: ABS plastic

Packaging: Carrying box with built-in resilient plastic handle for plates and triangular carton box for panel wrap

OPTIONAL PARTS & ACCESSORIES

45611 Bottom Plate, Light Grey, diam. 22" (56 cm)

45612 Top Plate, Light Grey, diam. 22" (56 cm)

45613 Middle Plate, Light Grey, diam. 22" (56 cm)

46115 Wrap for Round-Up, Frontrunner, Black

PACKAGING: Carton boxes

The wrap comes in a re-usable protective triangular carton box cut to fit the height of the wrap.



The plates come in a sturdy re-usable carrying box. The built-in resilient plastic handle makes it convenient to take on the go. One box can hold one set of top and bottom plates, or one middle plate.

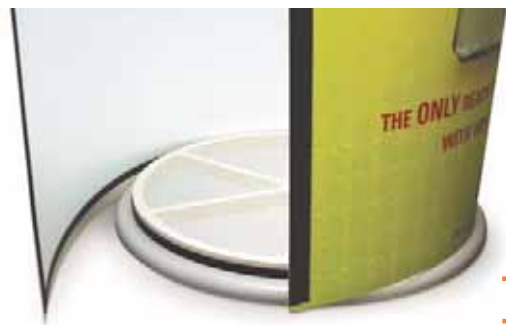

46/47

ROUND-UP



top & bottom plates
diam. 22" (56 cm)

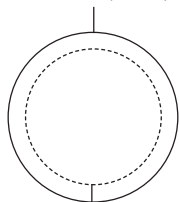

graphic panel
diam. 20" (51 cm)

1" (2.5 cm)
Velcro tape or
magnetic tape
(on the front
of the wrap)

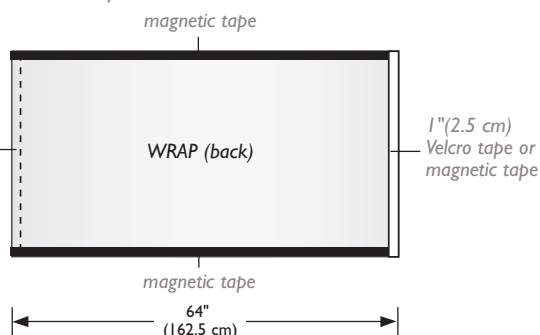

The wrap is vertically connected with Velcro tape or magnetic tape and attached to the plates with magnetic tape. The magnetic tape on the top and bottom of the wrap is cut 1" (2.5 cm) shorter as not to overlap the Velcro tape.

The two vertical ends of the wrap join to each other by overlapping Velcro tape or magnetic tape A onto tape B.

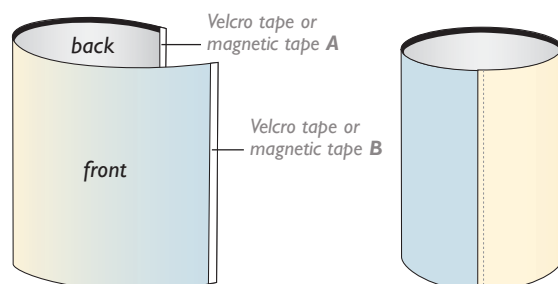

ROUND-UP

WRAP: Customized height

The wrap can be customized to desired height. For height above 60" (152.4 cm), it's recommended to split the display using a Middle Plate.

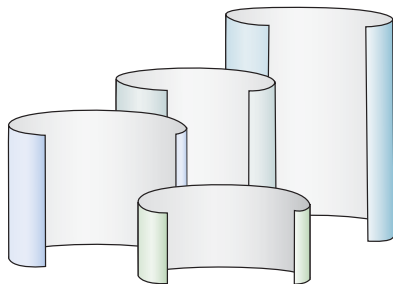

Graphics define the height of the unit.

PLATES: ABS plastic

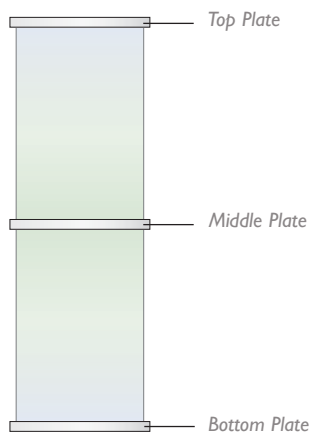

TOP PLATE
w. connecting ring underneath



MIDDLE PLATE
w. connecting ring on both sides



BOTTOM PLATE
w. connecting ring on top side

SET-UP COMBINATIONS: Single or Stacked

You can create your own displays by combining wraps and plates. It's as quick to assemble (estimated 30 seconds) as it is easy to exchange panels. With the help of Middle Plates you can change the set-up configuration or just add-on when the need arises.





VERSATILE PANEL MATERIALS:

The wrap can be made out of an array of different materials such as graphic panel, Fronrunner fabric, transparent plastic for creating a showcase, or translucent material for backlit.

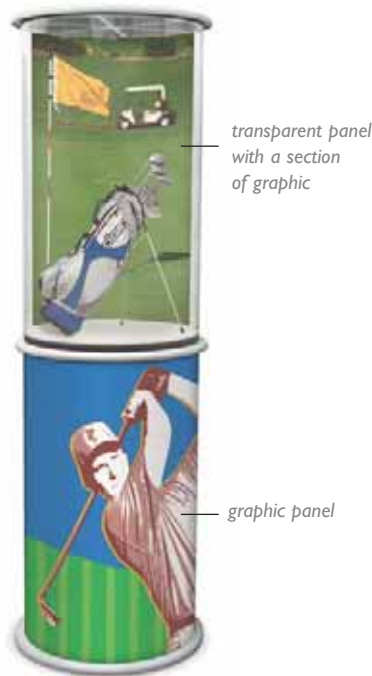

Vinyl graphic can be mounted on the transparent panel to add a dynamic look to your showcase.



Fronrunner fabric

Vinyl graphics with Velcro tape can be attached to the surface of the Fronrunner fabric.

APPLICATIONS:

Combine with other Accenta products for different display purpose.



with Pop-It-Up



with FabricWall

PROMOTOR

Show Them What You've Got!

Promotor is a portable demo tool, sampling stand and info booth. Choose black or white polypropylene and customize the curved base and roomy header with your graphics. Its worktop is as durable as its inner shelves. And when the show is over, it folds flat and travels light and hassle-free in its own nylon bag. Go ahead. Show and tell.





SPECIFICATIONS

Complete Promotor unit in polypropylene with built-in "hinges" for easy folding. Vacuum formed super high impact polystyrene top. Incl. Header panel, inside shelf and a black padded nylon carrying case. Graphic panels optional.

- 38201** Promotor unit, White
(32 1/2" W. x 86 5/8" H. x 19 1/4" D. (82.6 W. x 220 H. x 49 D. cm)
- 38203** Promotor unit, Black
(32 1/2" W. x 86 5/8" H. x 19 1/4" D. (82.6 W. x 220 H. x 49 D. cm)

Weight: 26 lbs. (12 kg)

Base material: Polypropylene and polystyrene

Packaging: Padded nylon carrying case

OPTIONAL PARTS & ACCESSORIES

- 38239** Full colour Graphic Panels for Front & Header Board
- 38259** Pair of full colour Graphic Side Panels

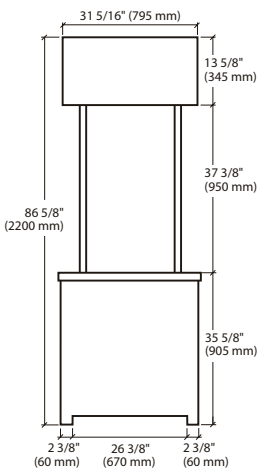

UNIT:

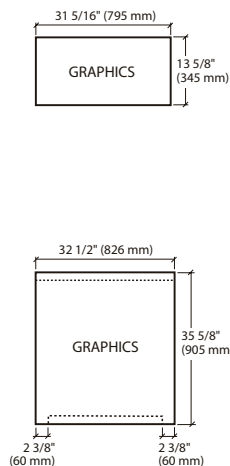
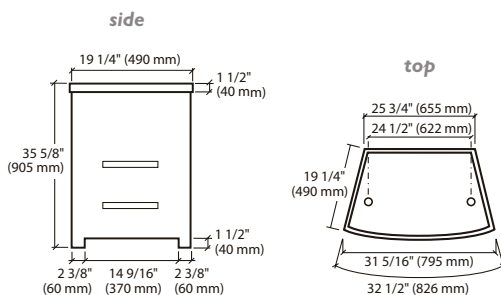

GRAPHIC:

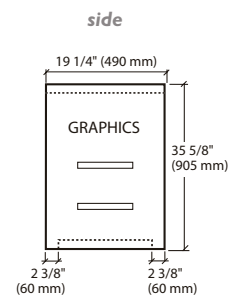

FLAGSTAND

Put the Flags Out!

Flag some attention. This movable flag display has a sturdy base that fills with water or sand. It can withstand "near gale" force winds of up to 32 mph. Its clear anodized aluminum telescopic flagpole is height-adjustable and makes it work as well indoors as it does outdoors. Fly one, two or three flags on a single stand. FlagStand can handle it. And should you ever need to store it or move it, this display even comes with its own handsome Oxford cloth bag.

FlagStand, we salute you.



SPECIFICATIONS

FlagStand, complete unit with black Oxford cloth bag. Graphic panel not included.

33501 FlagStand, complete hardware kit (for one flag), max. height 212 1/2" (540 cm)

Weight: 36 lbs. (16.3 kg)

Base material: PVC plastic

Flag Pole: Clear Anodized Aluminum

Graphic panel: Several options available

Packaging: Black cloth bag

The 3-section pole can be fully extended to 3 different heights.

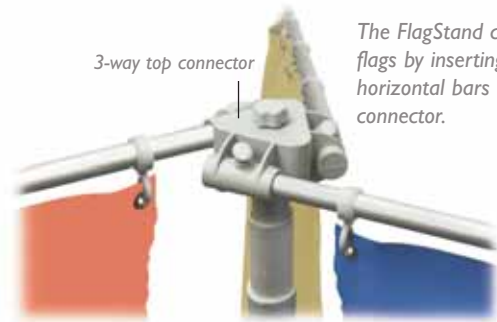
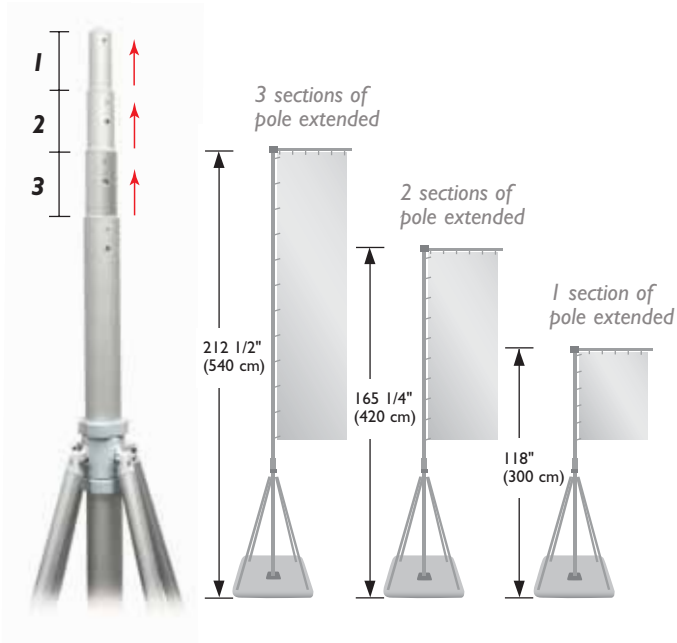

The FlagStand can hold three flags by inserting another two horizontal bars into the top connector.



To extend one section of the pole, simply pull up the pole until the pole stop pops up to lock into place.

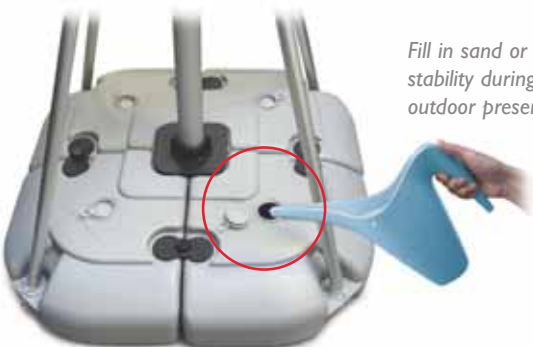

Fill in sand or water for stability during long time outdoor presentation.



Lock each of the four poles onto the corner of the base.



Side pole locked.

TRANSPORTCASE 1

Ship and Show.

Traveling can be a bumpy road. Protect valuable graphics or displays with this rugged shipping case. Choose a size – tall or short – and opt for a graphic banner wrap to convert it into a display counter. Pack it up and hit the road.

SPECIFICATIONS

Multi-purpose TransportCase in sturdy roto-molded plastic incl. casters, handle and lockable linklocks.

46112 TransportCase, Low

46114 TransportCase, High

OPTIONAL PARTS & ACCESSORIES

46116 Wrap for low TransportCase, Fronrunner, Black

46118 Wrap for high TransportCase, Fronrunner, Black



46114

46112

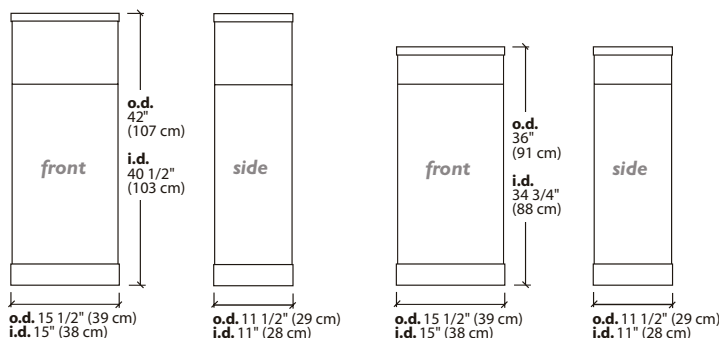

ALTERNATIVE CONTENTS:

- 5 Roll-It-Up 4
- 6 Roll-It-Up 1
- 3 Roll-It-Up 3
- 4 ImageStand 1
- 4 ImageStand 2
- 1 FabricWall 2x3 + 2 Roll-It-Up 1
- 1 FabricWall 3x3 + 2 Roll-It-Up 1
- + (unlimited possibilities)

TRANSPORTCASE 2

Double Agent.

54/5

TRANSPORTCASE 1 & 2

Make your case with this double-duty transport container. Use it to ship your display. Store up to two spotlights in its lid. Link locks make it travel safe. At the show, wrap the base in a graphic panel and convert the top shelf into a counter to make it into a podium. You don't have to think twice.

SPECIFICATIONS

Multi-purpose TransportCase in sturdy roto-molded plastic incl. casters, handle, lockable linklocks and adjustable partition.

46100 TransportCase

OPTIONAL PARTS & ACCESSORIES

46110 Top Shelf for TransportCase, Grey

46111 Top Shelf for TransportCase, Black

46115 Wrap for TransportCase, Frontrunner, Black



46110



46115



46100

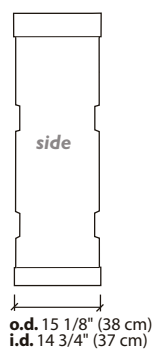
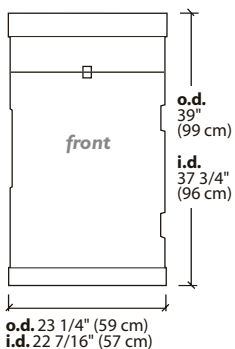

Lid has protective foam insert to hold 2 spotlights.



ALTERNATIVE CONTENTS:

- 8 Roll-It-Up 4
- 10 Roll-It-Up 1
- 5 Roll-It-Up 3
- 8 ImageStand 1
- 8 ImageStand 2
- 4 FabricWall 2x3
- 3 FabricWall 3x3
- 2 FabricWall 4x3 + 4 Roll-It-Up 1
- 1 Complete Pop-Up system
- + (unlimited possibilities)

SOFTCASE

A Smart Bag!

You can take it with you. Carry it or roll it.
 This clever case comes with in-line wheels and padded shoulder straps. Its ergonomic design makes it as comfortable as it is functional.
 Durable nylon lets it take a beating and come out looking great. Designed to accommodate a variety of products.

SPECIFICATIONS

- 36303** SoftCase, Small, 11 1/2" W. x 34" H. x 10" D.
 (29.2 W. x 86.4 H. x 25.4 D. cm)
- 36305** SoftCase, Large, 13 5/8" W. x 36" H. x 12" D.
 (34.6 W. x 91.4 H. x 30.5 D. cm)

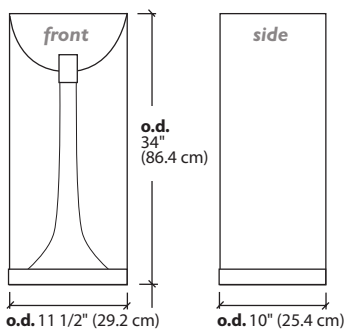

36303



Alternative contents shown here is for small SoftCase only.

ALTERNATIVE CONTENTS:

- 4 Roll-It-Up 4 or Roll-It-Up 1
- 4 FabriCounter
- 4 ImageStand 1 or ImageStand 2
- 3 Roll-It-Up 3
- 2 FabricWall 2x3
- 1 FabricWall 3x3 + 1 Roll-It-Up 3
- 1 FabricWall 3x3 + 2 Roll-It-Up 1
- 1 FabricWall 4x3 + 1 Roll-It-Up 3
- 1 FabricWall 4x3 + 2 Roll-It-Up 1
- + (unlimited possibilities)